

STAINLESS STEEL STONE ANCHORS

#718 STONE ANCHOR

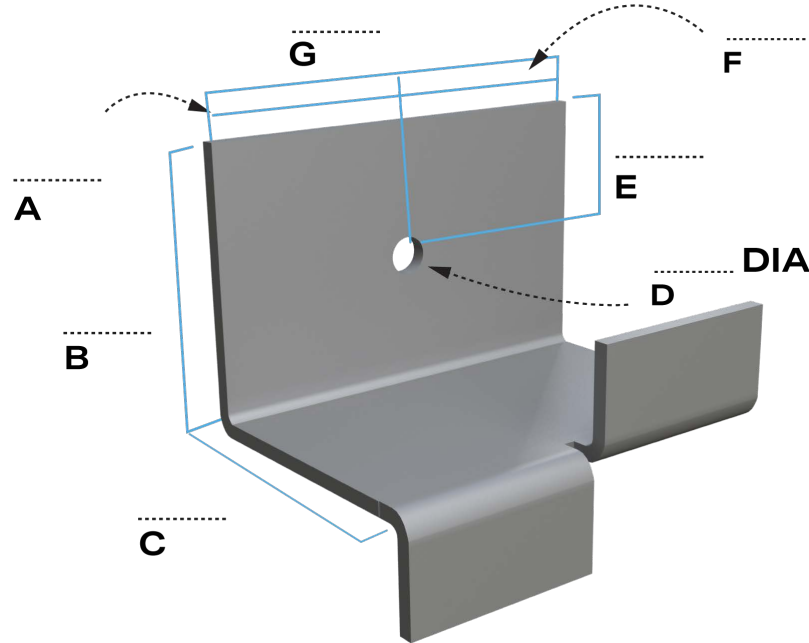

ASTM STANDARDS:

ST/ST Plate Min. Fy. = 45,000 p.s.i. (ASTM A666)

ST/ST Rounds Min. Fy. = 75,000 p.s.i. (ASTM A276/A276M)

Product Details:

QUANTITY:

FINISH	THICKNESS:
SS 304	12 ga
SS 316	1/8"
	3/16"
	1/4"

NOTE

The information provided herein is for general informational purposes only and does not constitute a professional opinion or engineering judgment. It is not intended to replace the design, detailing, or project-specific determinations of the licensed architect or engineer of record.

Each project is unique. The selection, application, suitability, and proper installation of these products are the sole responsibility of the design professional and installer based on project-specific conditions, substrate, exposure, and applicable codes.

All products and information referenced herein are subject to 3GEN Masonry Products, Inc.'s Terms and Conditions of Sale, including all limitations of liability, disclaimers of warranties, and exclusive remedies, as published and in effect at the time of sale.

In order to email your submittal sheet information, you must have Adobe Acrobat installed on your computer.

Mailing Address

8528 Davis Blvd., #134-246 North
Richland Hills, TX 76182 Tel#:
1-800-556-5785

3genmp.com

Warehouse Address

8550 Parkway Drive Leeds,
AL 35094 Tel#:
1-800-556-5785