

STAINLESS STEEL STONE ANCHORS

#712 STONE ANCHOR

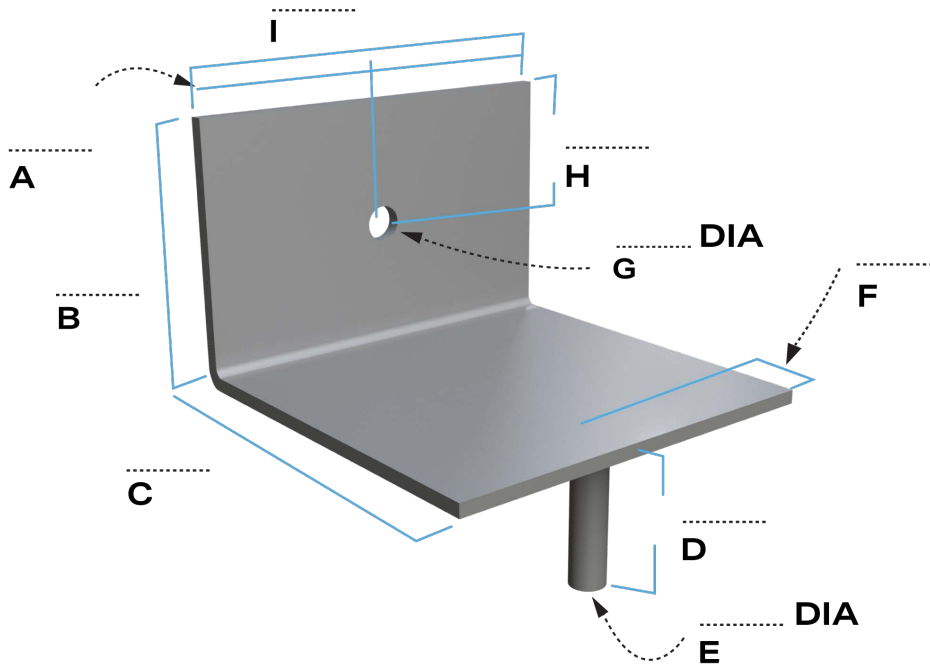

ASTM STANDARDS:

ST/ST Plate Min. Fy. = 45,000 p.s.i. (ASTM A666)

ST/ST Rounds Min. Fy. = 75,000 p.s.i. (ASTM A276/A276M)

Product Details:

QUANTITY:

FINISH	THICKNESS:
SS 304	12 ga
SS 316	1/8"
	3/16"
	1/4"

NOTE

All information, data, and recommendations on this submittal are provided for general informational purposes only and do not constitute any warranty, guarantee, representation, or professional opinion. No reliance shall be placed on this information. Product selection, suitability, design, installation, and code compliance are the sole responsibility of the architect, engineer, design professional, and contractor. All Products are provided subject to 3GEN Masonry Products, Inc. Terms and Conditions of Sale, including all limitations, disclaimers, exclusive remedies, and indemnity obligations.

In order to email your submittal sheet information, you must have Adobe Acrobat installed on your computer.

Mailing Address

8528 Davis Blvd., #134-246 North
Richland Hills, TX 76182 Tel#:
1-800-556-5785

3genmp.com

Warehouse Address

8550 Parkway Drive Leeds,
AL 35094 Tel#:
1-800-556-5785